



Table Of Contents

2 INTRODUCTION

2 SCREENS & FUNCTIONS

- 2 Main Screen
- 3 Setting Time & Date
- 4 Main Menu
- 5 Schedules
- 6 Schedule Editing
- 7 Event Editing
- 8 Schedule Copy & Delete
- 9 Holidays
- 10 Daylight Savings Time
- 11 Configuring Security & Outputs
- 12 USB Import & Export
- 13 System Inputs & Outputs

14 TECHNICAL DATA

- 14 5400-ES Dimensions
- 15 5400-ES Wiring
- 16 Specifications





INTRODUCTION

The Artisan Controls Model 5400-ES event and bell controller provides a modern graphical user interface via it's 3.5" diagonal color display and includes two 10A relay contact outputs, two 5A relay contact outputs , two switch inputs, and a USB port for importing and exporting the controller configurations.

MAIN SCREEN

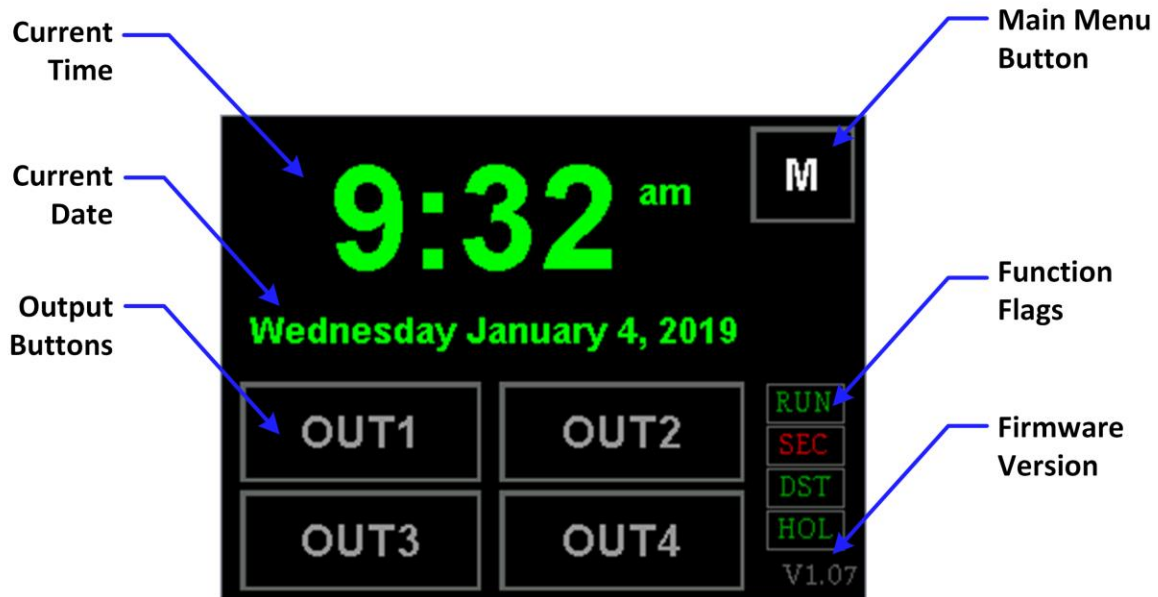

The main screen of the controller indicates the current time and date, the state of the four outputs, function flags that indicate whether the controller is running the output schedules, has security enabled for accessing the controller schedules and configuration, and whether holidays are enabled and active.

Function Flags -

blank or **[RUN]** = Controller outputs are activating according to their schedules.

[RUN] = Controller outputs are disabled.

blank = No access code required for menu access.

[SEC] = Either the switch input is closed or the controller will require entering an access code.

[SEC] = A switch input needs to be closed to gain access.

[DST] = Daylight Savings Time is enabled, **[DST]** = is it disabled.

blank = Holidays not enabled or active.

[HOL] = Holidays have been enabled and the outputs are active

[HOL] = Today is configured as a holiday and the outputs are inactive.



MAIN SCREEN (cont)

Time and Date -

To update the time and/or date simply touch either the time or date on the main screen and this window appears:

To change any item (other than the am/pm) simply touch the item and it is highlighted in green. The window to the right shows the hours being highlighted. To change the value use the plus and minus buttons on the right side. To change the am to pm and vice versa simply touch the item and it toggles back and forth.

To exit without changing press the red X in the upper right hand corner. to save the new values press the [SAVE] button. The system save the new values and return to the main screen.

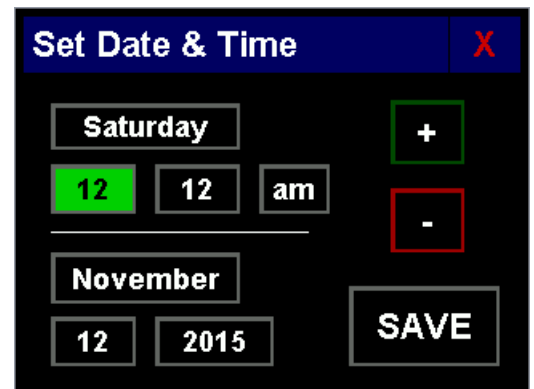

Output Buttons -

Touching any of the output buttons displays the events in its schedule, this event occurs at 7:00 am, the output is turned ON, and this happens Monday thru Friday but not on Saturday or Sunday. More details about events are in the Scheduling section later in this manual.

Touching *and holding* an output button for two seconds until it double chirps manually changes its state from on to off or off to on.

Buttons for outputs which are turned on are filled with green, otherwise they are black. Outputs whose schedules are disabled will be black and there will be no name visible in the button. Disabled outputs cannot be changed by holding their buttons down nor are their schedules available for viewing.

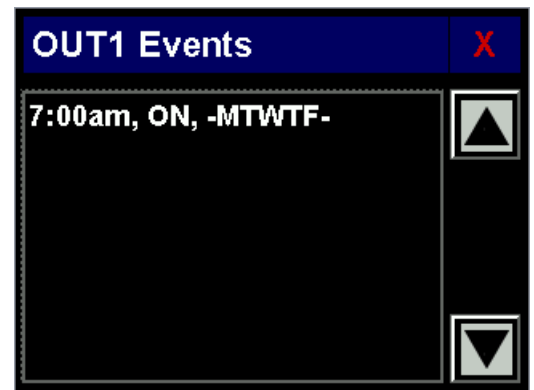

Main Menu Button -

Pressing the [M] button in the upper right hand corner will access the Main Menu screen from which the output schedules are managed, holidays can be configured, the controller security and input functions can be configured, and the controller configurations and schedules can be imported and exported.



MAIN MENU

If password security has been enabled the access code entry window (below) will appear requesting the 4 digit code. This screen will show the digits as asterisks for security. Pressing the [Clear] button clears the digits already entered, pressing the [ENTER] button uses the entered digits to attempt to access the main menu. If password security is not enabled the controller will display the main menu screen below.

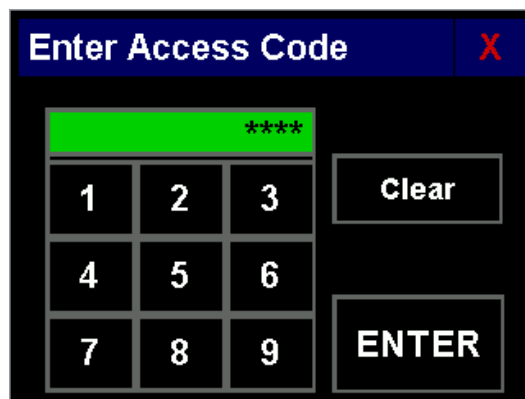

MAIN MENU FUNCTIONS:

[Schedules] = Edit, copy, and delete output schedules.

[Holidays] = Configure and enable holidays

[Daylight ST] = Configure and enable Daylight Savings Time.

[Configure] = Set security code and enable/disable security, configure switch input functions, and set the output channel names.

[USB] = Use a USB flash drive to save or read output schedules and controller configurations.

[System] = Test controller inputs and outputs, reset back to factory defaults

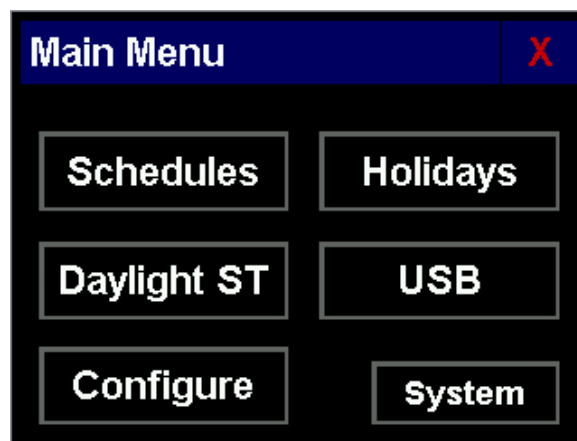



SCHEDULES

The 5400-ES has the capacity for storing up to 128 events. Events can be created for any output and all the events for an output is called a schedule.

NOTE: Users of our 4950 series controllers please read this section carefully as we have designed the events for this new controller differently than you are familiar with on your 4950. This one controller can perform all the function of the 4950B bell controller, 4950H event controller, and all controllers derived from those products!

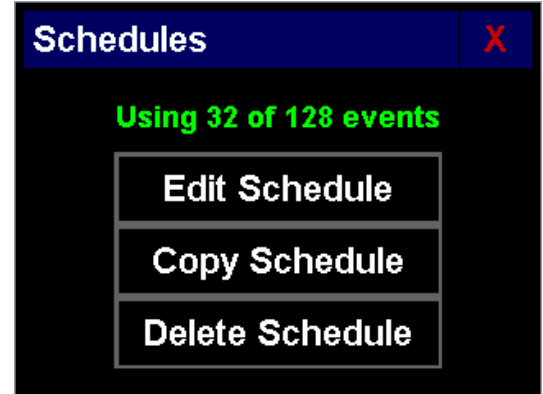

Important Features:

1. Any number of the 128 available events can be used for an output schedule, *there are no limitations.*
2. Each event can be configured to be active on *any or all of the days of the week.*
3. The events *do not have to be entered in sequence*, the controller automatically sorts them into proper time order for each output.
4. The output events and system configurations are saved in non-volatile memory which will retain your settings for up to *10 years with no power.* Losing power to the controller will not affect the schedules, it will only affect the current time and date and only if power is off for more than 5 days.

NOTE: When saving or deleting events and schedules the controller will chirp twice to indicate that your changes have been saved to the non-volatile memory. A long beep indicates that it was not saved and should be tried again.

Press the **[Edit Schedule]** button to begin with the screen below, then press the button for the output schedule you want to edit:

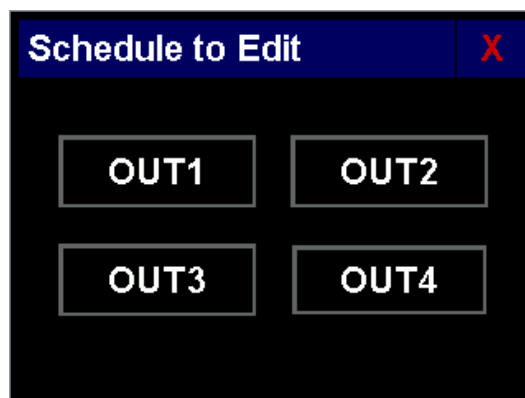

SCHEDULE EDITING

Once you select the output to edit its schedule is displayed in the window to the right. All the events are sorted and shown in sequence, the up and down arrows allow you to scroll page by page through all the events. Touching an event will highlight it with red text on a white background.

[Add] = Create a new event and add it to the schedule.

[Edit] = Edit the highlighted event.

[Copy] = Copies the highlighted event to a new event

[Del] = Deletes the highlighted event.

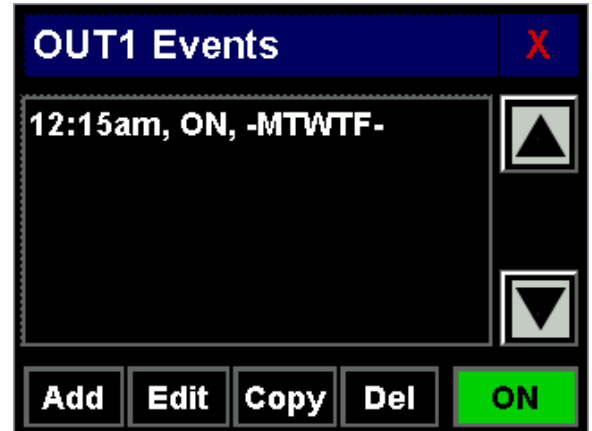

The **[ON]** button indicates that this output schedule is active. Touching this button disables the schedule, the button turns black and the text changes to **[OFF]**. Touching the button again re-enables the schedule, the button turns green and the text changes to **[ON]**.

Touching the [Add], [Edit], or [Copy] buttons displays the event editing window:

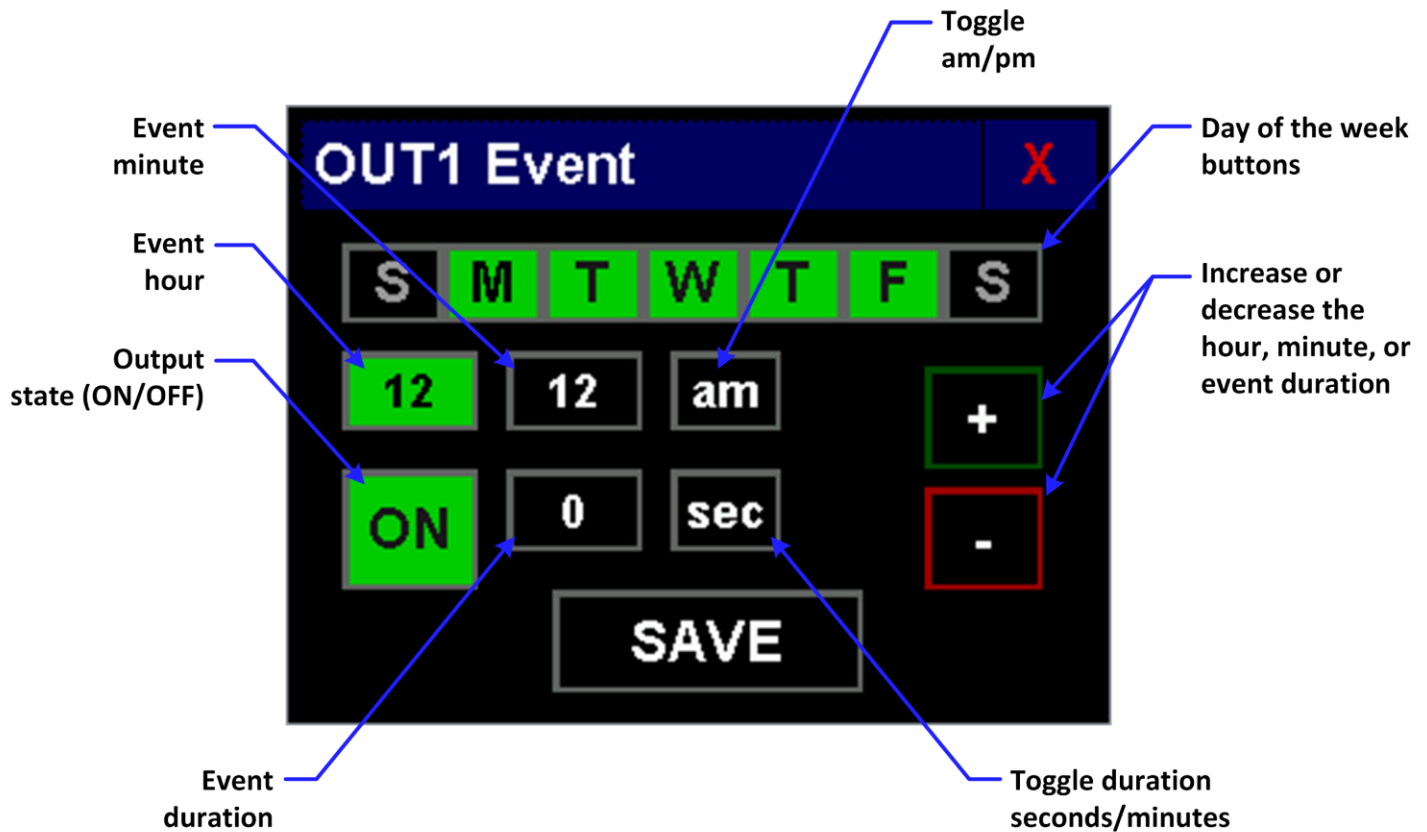



EVENT EDITING WINDOW

Day of the Week:

The day of the week buttons allow you to enable this event for any of the days in the week, [S] = Sunday, [M] = Monday, etc. A green button indicates that this event will be active that day, black means that it is not. Touch the button to change that day between its active and inactive states.

Event Hour and Minute:

Touching the hour or minute item highlights it, then use the plus and minus buttons to change the value. Touching the [am] button changes it to [pm] and vice versa.

Output State:

The output state button is either [ON] and green or [OFF] and red:

[ON] = Output turns ON when the event is activated.

[OFF] = Output turns OFF when the event is activated.

Event Duration:

The event duration determines how long the output stays in that state:

1. An event duration of 0 means that the output goes to the programmed state and stays in that state until another event changes it.
2. An event duration greater than 0 means that the output will take the programmed state for that length of time in second or minutes then change back.

*Press the red X to exit without saving, press **[SAVE]** to save the event and return to the schedule window.*

Event Programming Notes:

Event durations of 0 (state changes) are most useful when you want to turn something on in the morning (such as an elevator or a coffee pot) and turn it off at night. This requires two events, one to turn the output ON and another to turn it OFF.

Non-zero event durations are useful for programming bell sequences for schools or factories. You can program an output to turn on for 5 seconds 10 minutes before the end of a period, and then for 10 seconds when the period ends.

Programming Tip – When programming for bell sequences you can use the [Copy] button to make it easier to create your events. Create the first bell event, configuring your time, duration, and active days and save it. Then highlight it in the event list and press [Copy]. The original event is copied to a new event so all you need to do is change the time and save it!

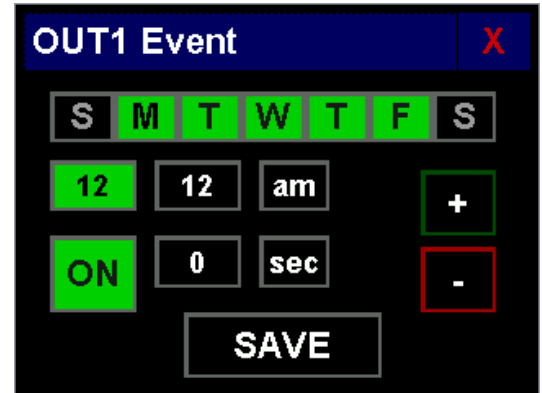



SCHEDULES (cont)

[Copy Schedule] allows you to copy schedules from one output to another with just a few button pushes.

Press the **[Copy Schedule]** button the window on the right opens. When this window first loads none of the From or To buttons are highlighted and the **[COPY]** button is blank. Press the button for the output schedule you want to copy from and it turns green if it has a schedule. Then press the output button you want to copy the schedule to and it highlights.

If the from output has events and there are enough events available in the system the **[COPY]** button will now show COPY. Press the button and all the events are copied.

Programming Note: This can be used to store different schedules for different times of the year ... For example you can create a schedule for the winter months and save in one output and then create a summer schedule and save it in another output. Those two 'storage' outputs need to be disabled but they can still store a schedule while disabled. Then each season you delete the schedule in the active output and copy in the appropriate schedule. Each output can be assigned a name (up to 7 characters) which can help you remember which season is saved in which output.

[Delete Schedule] deletes all events in the selected output or in all outputs. Press the **[Delete Schedule]** and the window to the right appears.

Simply press the button corresponding to the output schedule to delete, or press the **[Delete All]** button to clear all the schedules.

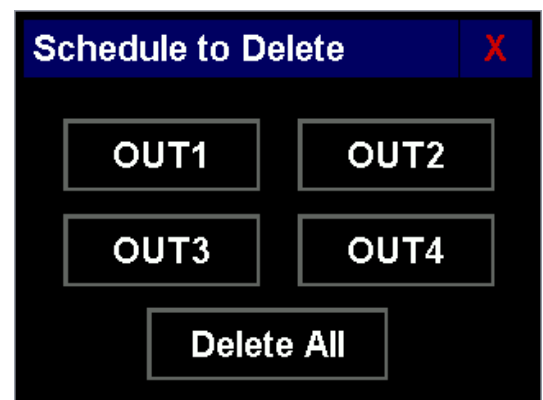
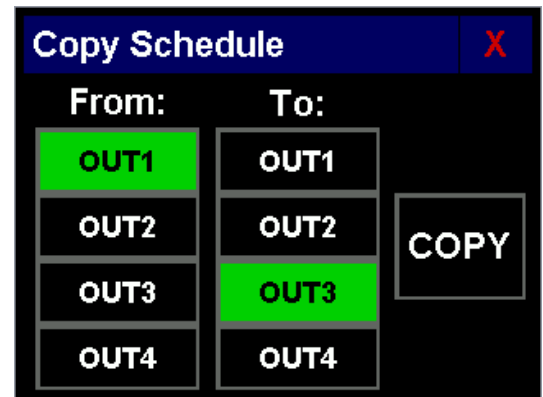
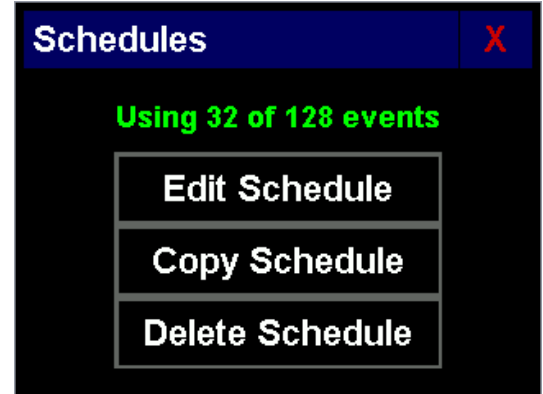



SCHEDULES

Finally, the controller is constantly checking the current output schedules and taking action upon them, even during schedule editing. If you add or delete an event, once it is saved the controller scans the entire schedule and sets the output appropriately. If you want to prevent this, simply disable the schedule until you are done editing it. Alternately, you can disconnect the output connector.

HOLIDAYS

The 5400-ES controller allows you to enter up to 15 holidays. On a holiday all output schedules are disabled and the outputs will be turned off from midnight to midnight.

Press the **[Holidays]** button and the window to the right appears, showing the 15 holidays and whether the holidays are enabled or disabled.

To enable the holidays press the button to the right and it turns ON, press it again and it turns OFF.

A value of "----" in a holiday button shows that it is not configured. Press any of the holiday buttons and the window on the right appears showing the month and date.

Press the **[+]** or **[-]** buttons to the right of the month change the month, and the same buttons to the right of the date change the date. Pressing the **[Clear]** button sets them both to dashes which means that is not configured.

Press the **[SAVE]** button to save the holiday and you return to the first window showing the holiday configuration.

Similar to editing events, you do not have to enter holidays in calendar sequence.

If holidays are enabled the holiday function flag in the main window will be visible. If the current day is not configured to be a holiday it will display as **[HOL]**. If the current day is a holiday in the current configuration the function flag will display as **[HOL]** indicating that the outputs are disabled.

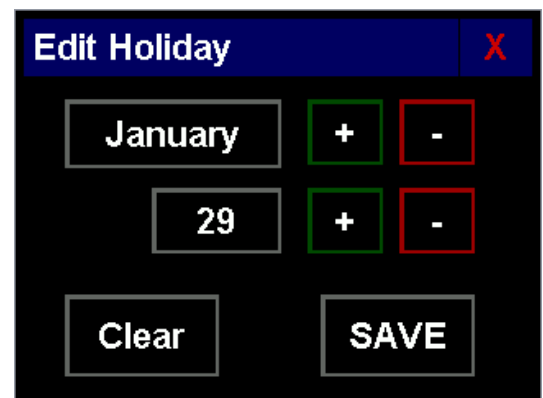
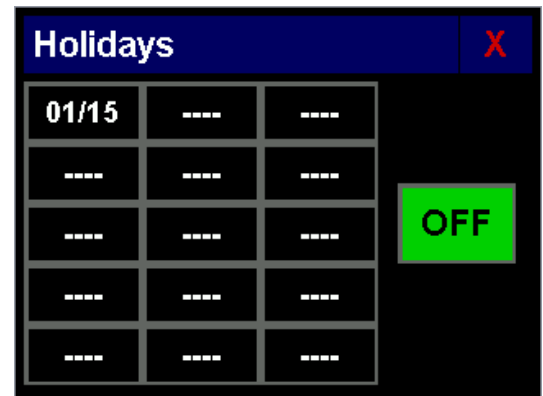



DAYLIGHT SAVINGS TIME

The 5400-ES controller allows you to edit and enable or disable Daylight Savings Time. The clock is always changed at 2 am, forward 1 hour in the spring and backwards one hour in the fall. The dates are set to the current default values of March 10th and November 3rd.

Press the **[Daylight ST]** button and the window below appears, showing the spring and fall dates and whether it is enabled or disabled.

To enable Daylight Savings press the button to the right of **Enabled:** and it turns green and says ON, press it again and it turns back to black and says OFF.

To change the dates, touch the month or date to highlight it and then press the [+] or [-] buttons to change the value

Press the **[SAVE]** button to save the configuration and you return to the main menu window.

Effect on programmed events:

Spring – Any short term event which is programmed to occur between 2:01 am and 2:59 am will be skipped on the spring clock changing, events at 2:00 am and 3:00 am may not be acted upon. State change events (turning an output on or off) at anytime between 2:00 am and 3:00 am will be activated when the clock changes from 2:00 am to 3:00 am.

Fall – Any short term event between 1:01 am and 1:59 am will be repeated according to the schedule, state change events at anytime between 1:00 am and 2:00 am will be de-activated when the clock changes from 2:00 am to 1:00 am and then re-activated at the programmed time.

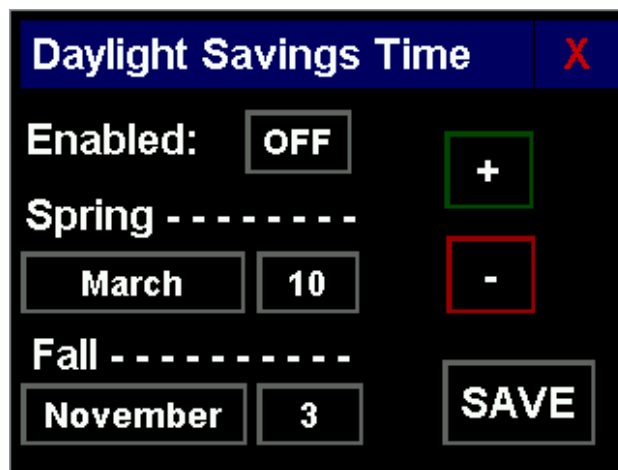



CONFIGURATION

The Configuration window serves multiple functions, changing and enabling the menu access code, setting the functions of the two switch inputs, and editing the output names. Press the [Configure] button and the Configuration window appears.

The access control is first, showing the current four digit code and whether access control is enabled.

The button to the far right is used to enable or disable the access control, touch it to change it from [ON] to [OFF] and vice versa.

Pressing the [Edit] button opens the access code window to change the current access code. Enter the four digits you want and then press [ENTER]. The [Clear] button clear any entered digits, and the red X button exits the window without making any changes

Main Screen Lock prevents the output states from being changed, touch it to change it from [ON] to [OFF] and vice versa.

The IN1 and IN2 buttons show the functions assigned to the two switch inputs. Touching these buttons toggles thru their different values:

[Off] = No function assigned.

[Security] = The input switch must be closed to have access to the main menu.

[Run/Stop] = The input switch must be closed for all outputs to run their scheduled events.

[AC Sync] = IN2 only for AC line clock synchronization

The function flags on the main screen indicate whether these functions are enabled and the state of the input switches. If neither switch is assigned to security but passwords are enabled the [SEC] flag will be displayed but will always be green.

The four buttons on the bottom show the names assigned to each output. Press any one of them and the output name editing window appears. Enter up to 7 letters, digits, or symbols and press [SAVE] to change the output name. This name will now appear on the main window and any other button associated with this output.

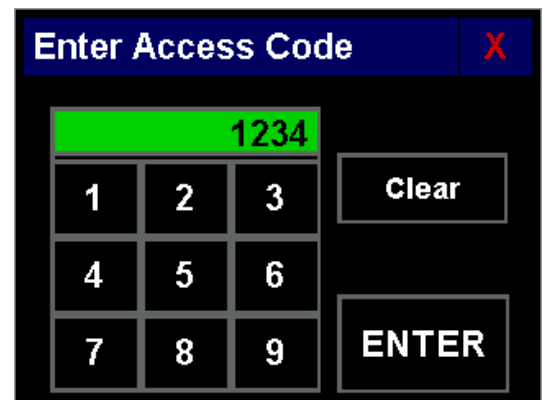
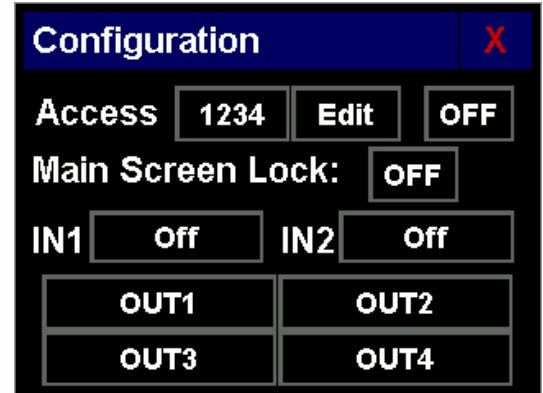



IMPORT / EXPORT

The 5400-ES can save and read information from USB flash drives up to 16Gb in size. Press the **[USB]** button in the main menu and this window appears.

NOTE: Do not insert the USB drive until you are in this window.

Once you insert the USB drive the controller indicates that it has detected it and the **[Export]** and **[Import]** buttons are enabled.

Export:

Press the **[Events]** button and all programmed events are stored with the file name of "EVENTS.CFG".

Press the **[Config]** button and the controller configuration and holidays are saved with the file name of "CONFIG.CFG"

Import:

Press the **[Events]** button and the controller looks for the file named "EVENTS.CFG" and reads the events from it. *Note: All current events are deleted before importing.*

Press the **[Config]** button and the controller looks for a file named "CONFIG.CFG" and reads the configuration and holiday data.

Press the **[CSV Schedule]** button and the controller finds all .CSV files on the USB drives and displays up to six files to choose from. *These files are exported from the Artisan Schedule template spreadsheet which allows the user to configure entire event patterns without using the controller.*

Touch the button for the schedule you want to import and the system deletes the output channel schedules being used, saves the new event schedule, and displays the number of events imported.

Removing the USB drive will exit this window and return to the main menu window. If you use the red X button to exit this window be sure to remove your USB drive.

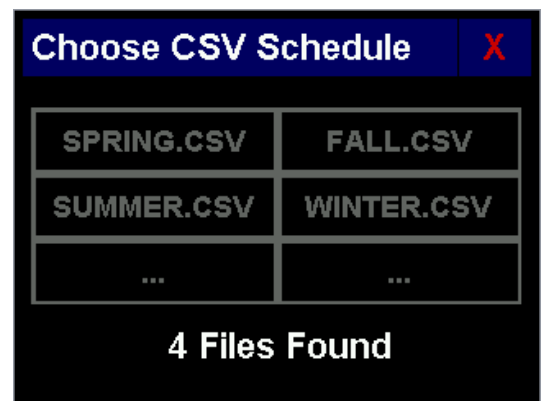
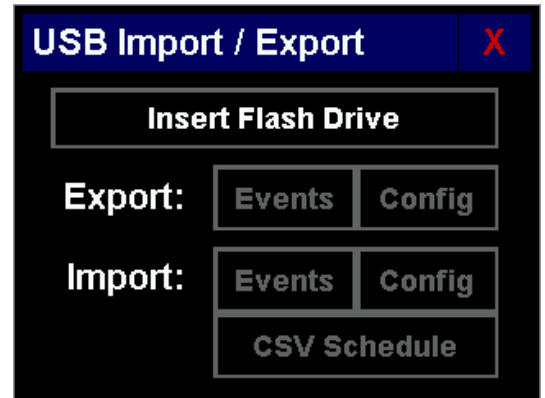



SYSTEM I/O

The **[System]** button in the main menu allows the user to check the proper functioning of the controller outputs and inputs, and also allows clearing the entire controller configuration back to the factory defaults. *You must press and hold this button for two seconds until you hear a double chirp.*

The **[OUT1]**, **[OUT2]**, **[OUT3]**, and **[OUT4]** buttons control their corresponding outputs. Touch the button once to turn it on (turns **green**), touch it again to turn it off. The **[IN1]** and **[IN2]** buttons display the state of the two inputs, **green** is on and black is off.

The **[Reset System]** button set the system configuration back to how it was delivered from the factory; no events for any outputs, all outputs enabled, no holidays, no security enabled, outputs named OUT1, OUT2, etc, and the access code is set to "1234".

*You must press and hold the **[Reset System]** button for two seconds until the double chirp to activate it.*

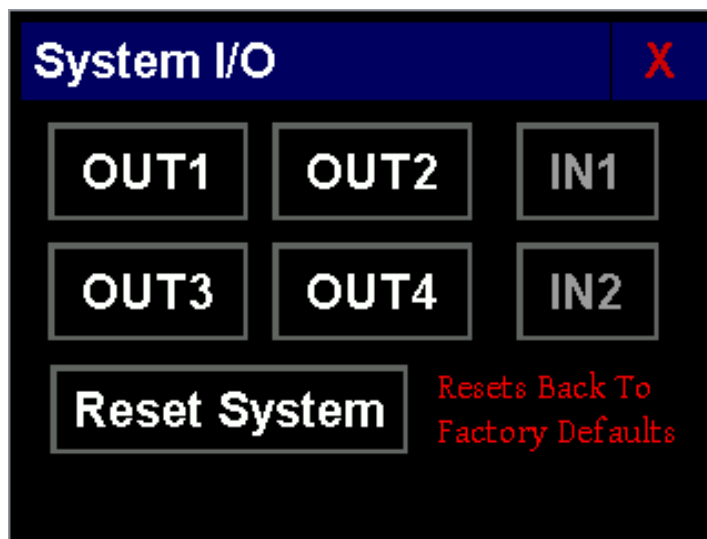



5400-ES DIMENSIONS



5400-ES Power Wiring With AC Line Synchronization

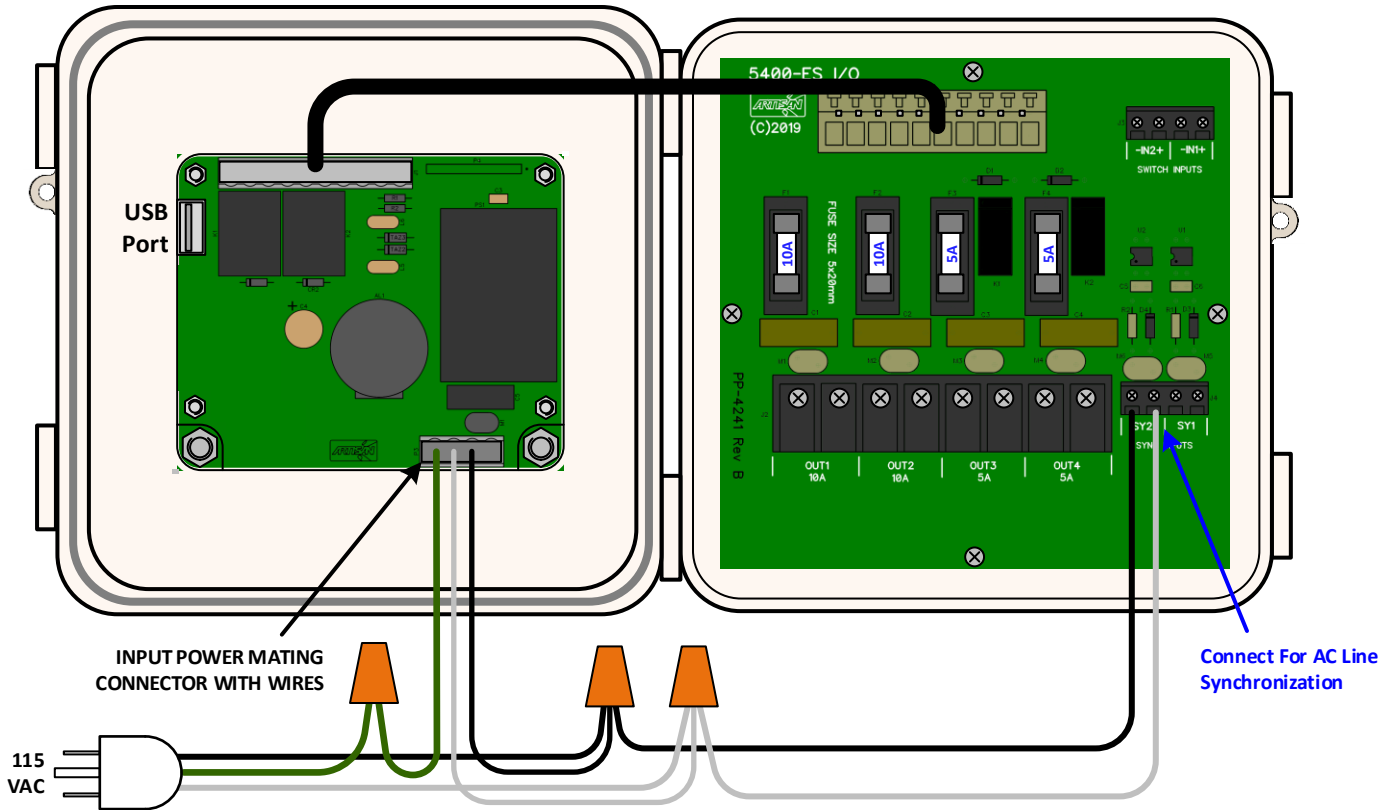

5400-ES Typical Wiring – Direct To Bells or To Alarm System

The 5400-ES outputs are normally open relay contacts, *there is no power connected to them*. They can switch any AC or DC power source directly to the bells, or they can be wired to the 'TEST' or 'ACTIVATE' inputs on most alarm systems.

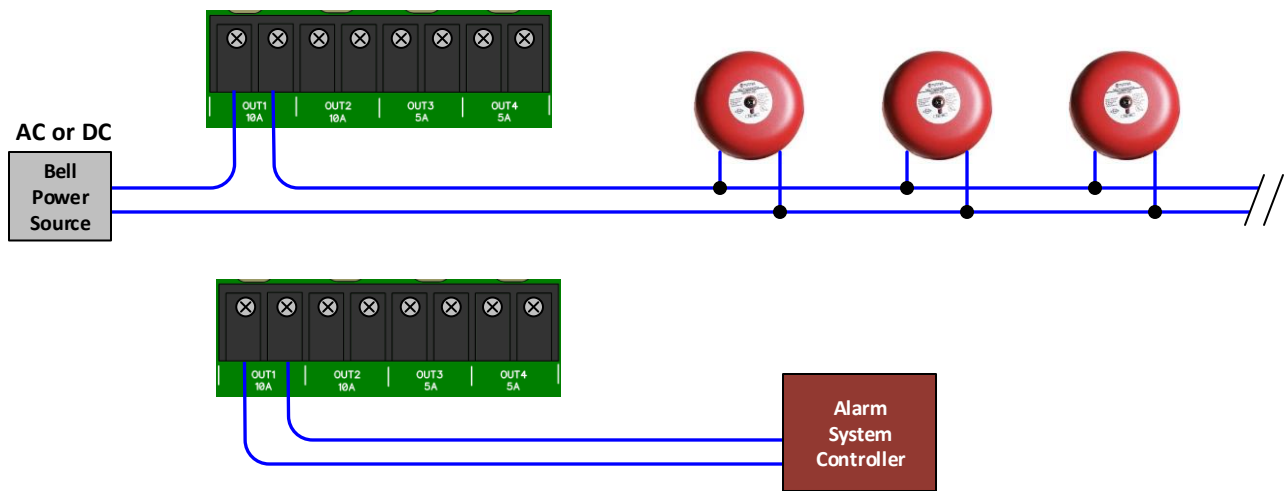



SPECIFICATIONS:

LCD DISPLAY: Color 3.5" diagonal TFT display, 320 x 240 pixels, 16 bit color, resistive touchscreen, 300 nits minimum.

INPUTS:

SW1 & SW2: Low voltage dry contact inputs, <5mA @ 5VDC

OUTPUTS:

OUT1 & OUT2: SPNO relay contacts rated 10A @ 125V, 7A @ 250V.

OUT3 & OUT4 = SPNO relay contacts rated 5A @ 125V.

FUNCTIONALITY:

Up to 128 events usable for any output, configurable for any number of days of the week.

REAL TIME CLOCK:

Accurate to ± 2 minutes/month without AC line synchronization, ± 20 seconds non-cumulative with AC line sync. Clock runs for up to 5 days without power or batteries.

ARCHITECTURE:

Microcontroller: 32 bit processor, 80MHz, w/floating point.

USB PORT:

Flash drive interface for importing & exporting output schedules and controller configuration.

CONNECTIONS:

Supply: 18 GA color coded wires, Input/Output: Screw terminal blocks

ENVIRONMENTAL:

Operating Temperature: 0°C to +70°C

AC POWER: 90-135VAC, 50/60Hz, 5W maximum

²- *Total external 5VDC current draw = 80mA maximum.*

VERSION HISTORY:

V1.04 – Oct 2016 – Corrected am/pm display, updated touchscreen calibration process.

V1.05 – May 2017 – Corrected issue with event display after event deletion.

V1.06 – Dec 2017 – Maintenance issue

V1.07 – Jan 2019 – Added Daylight Savings and 5400-ES

V1.08 – Jun 2019 – Added AC Line synchronization and detailed wiring

V1.09 – Oct 2019 – Added CSV event schedule import.